







**What your recipe needs**

**06**

**Company**

**10**

**Cucimix**

---

**12**

**Cucimix  
30 . 70 .**

**14**

**Cucimix  
90 . 130 . 180 . 310**

---

**16**

**The kitchen  
of the future  
is Cucimix**

**18**

**FTC**

---

**21**

**Pressure  
cooking**

**22**

**Cooking  
professionally  
and saving**

# 24

**Countless  
cooking  
modes**

---

# 26

**Versatility**

---

# 28

**Chef  
Alessio  
Bottin**

---

# 30

**MOF  
Pastry chef  
Angelo  
Musa**

---

# 32

**Technical  
features**

---

# 34

**Accessories**

---

# 36

**Options**

# We design and manufacture equipment for professional kitchens.



**Versatility  
is one of  
our secret  
ingredients.**

Backed by previous experience in the business, 25 years ago we founded **Firex** with the aim of designing and manufacturing equipment for the **food service, food processing and pastry sectors**. We have been committed ever since to ensuring that **Firex** stands for **safe, high-performance and innovative products** in the hands of chefs, food technologists and kitchen teams in every nation and continent, transforming the catering services into laboratories of taste.

## Artisans at the service of innovation.



### **We are manufacturers and we are proud of it.**

Stainless steel sheets come to life and take shape within our production site. Solid mechanics managed by digital intelligence at the service of our customers.

**Reliability, advanced functionality and precise control make life easier.**

We use exclusively high-chromium steel, AISI 304 and AISI 316, which we process partly with advanced machinery and partly manually starting from the sheets that we **cut, bend, weld and polish entirely in-house**. We are able to trace back each sheet of the finished

product, thus guaranteeing an exceptional and certified quality system.

**We pay close attention to our customers'** needs in order to design innovative solutions that combine the solidity of steel together with the most sophisticated technologies in the mechanical, electrical and hydraulic fields. **Firex** multidisciplinary team strive every day to satisfy the needs of the market promptly.

# CUC

**The perfect  
mix for your  
kitchen**



# I M I X



What your recipe needs

# Autonomy automation and consistency: Cucimix winning combination.

**The automatic  
mixer is laboursaving.**

**Cucimix:**  
**versatile cooker**  
with a high-tech core.

Made entirely of **stainless  
steel and extremely compact**  
even in models with  
greater capacity.

Can be equipped  
with **a variety of  
accessories** to  
suit every need.

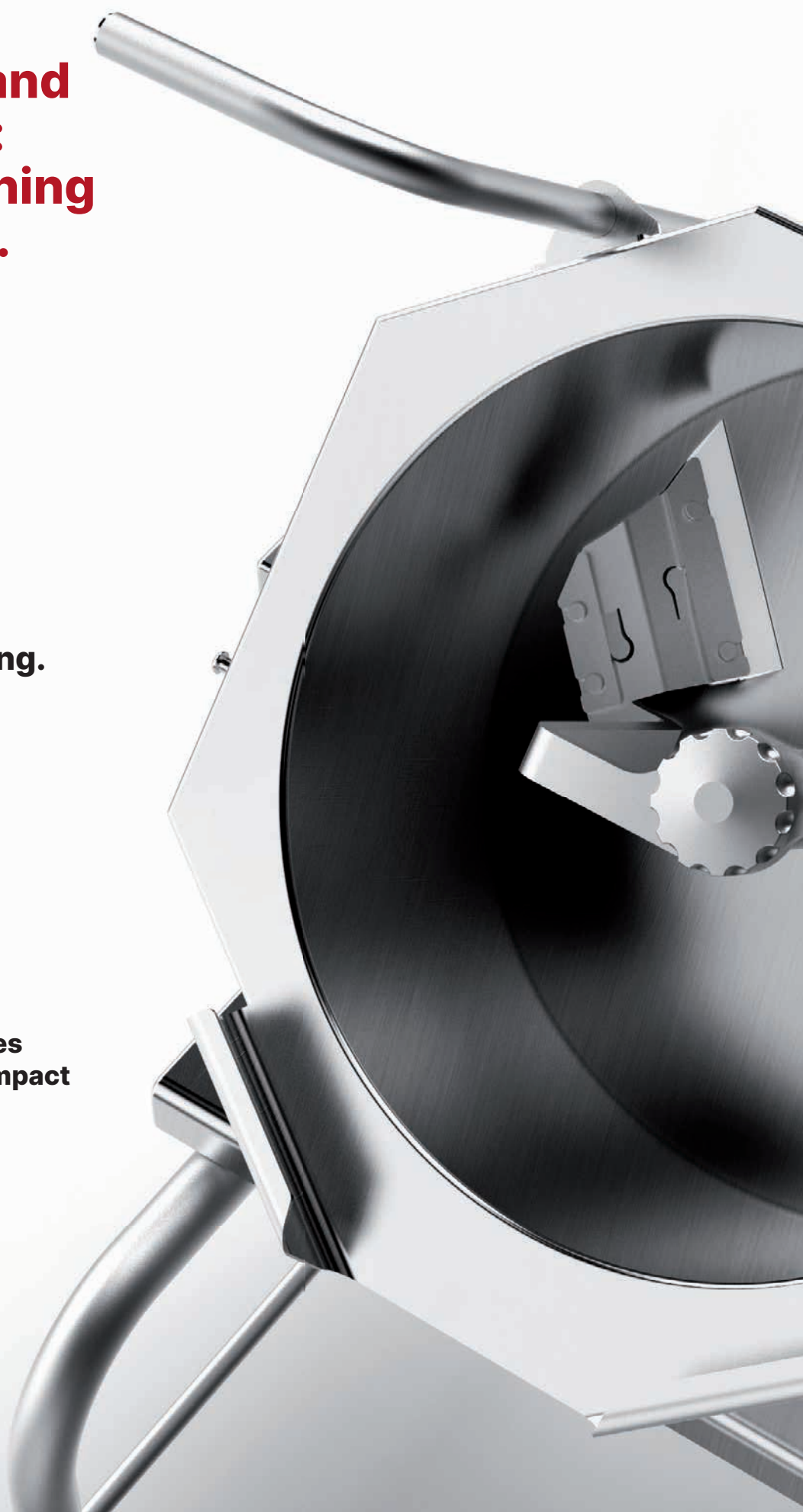



**A perfect mix.  
Guaranteed  
by Firex.**



## Models: 30 . 70 . litres

### Type of heating:

 Cucimix 30 . 70

 Cucimix 70

01

#### Heating temperature control probe

**Probe** inserted below the cooking surface, to adjust the temperature from **20 to 220 °C**.

02

#### Firex Touch Control

Practical and **intuitive latest generation** touch controller for setting and adjusting every function.

03

#### Probe in direct contact with the product

To manage even the most delicate cooking processes with extreme precision.



04

#### Mixer

A blend of cookery and technology. The 2-arm rotating device guarantees **great autonomy** in managing the cooking process. Rotation occurs in both directions and the speed can be adjusted from the electronic board. The mixer has scrapers made of teflon and steel that can be removed for cleaning purposes.

05

#### Wheels: dynamic and practical

The wheels offer the possibility to move around the machine and to be able to redesign the kitchen space according to your needs.

## Cucimix in the kitchen



### Smaller work spaces.

Thanks to its compact size, **Cucimix** can be installed also in narrow spaces.



### Safer and comfortable environment.

The mixer is designed and built to **reduce the physical strain of the operators** and avoid the risk of burnings.



### Process organisation.

Thanks to **Cucimix** control functions, **operators can easily plan the entire production process** and **better handle the different tasks in the kitchen.**



**Capacity:**  
**90 . 130 . 180 . 310 litres**

**Type of heating:**



01

**Automatic water loading  
in the 90 . 130 . 180 . 310 litres**

With litre meter for hot and cold water (up to 90°C).

02

Possibility to complete the machine with different types of discharge valves (**optional**).

03

**Feet made of steel**

adjustable height for levelling.

04

**Mixer: a combination of cookery and technology**

The 3-arm rotating device guarantees great autonomy in managing the cooking process. Rotation occurs in both directions and the speed can be adjusted from the electronic board. The mixer has scrapers made of teflon and steel that can be removed for cleaning purposes.

06

**A practical and intuitive latest generation touch controller** for setting and adjusting every function.



05

**Pressure lid available in the versions:  
130 . 180 . 310 litres**

The use of the pressure lid allows faster and more efficient cooking, with a **reduction in cooking times and energy consumption up to 70%**.

**The taste you  
want wherever  
you want it.**

From northern Europe all the way to south-east Asia passing through South America, **Cucimix** is the symbol of a food culture like no other in the world.

**Designed and manufactured entirely in Italy**, this bratt pan with integrated mixer represents a new way of cooking for the catering industry as it offers professional chefs the possibility of preparing their best recipes, replicating the quality and the unique taste of each individual preparation.

**In authentic Italian style.**



# Cucimix: the kitchen of the future

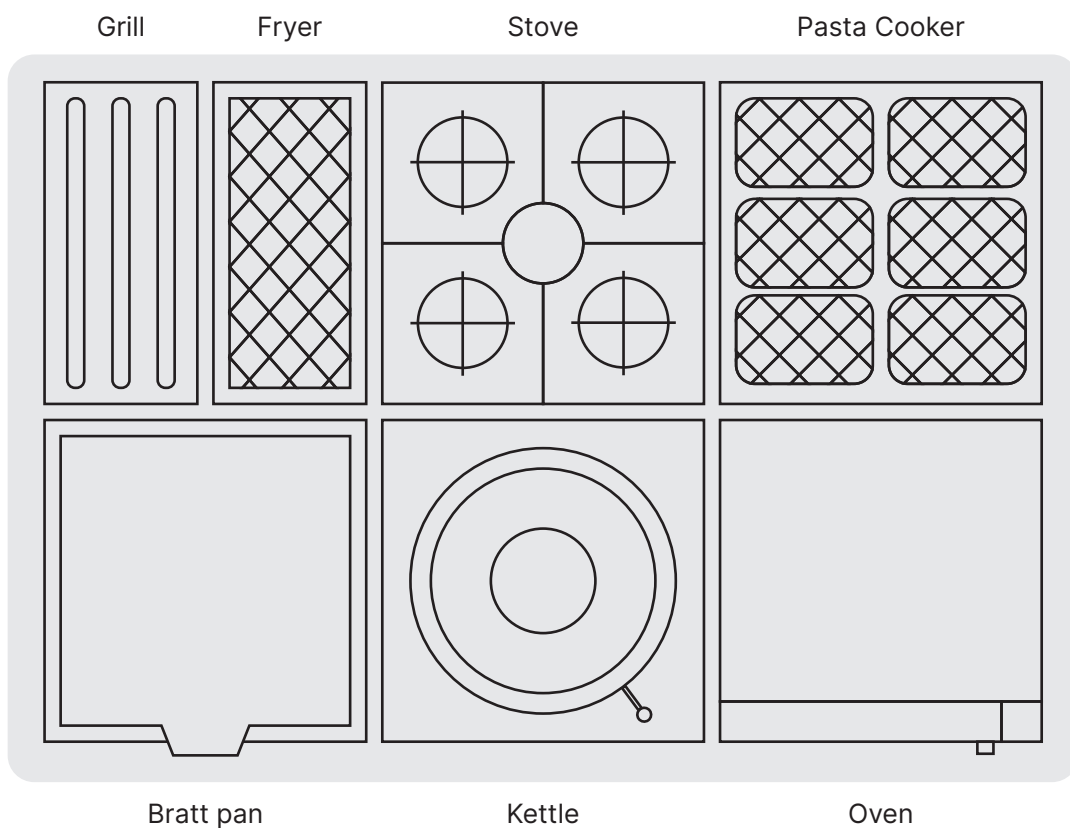

**Traditional kitchen: space used → 4,32 m<sup>2</sup>**

With **Cucimix** you get better results while **saving time, space and energy.**

**Pair Cucimix**  
with a multifunctional bratt pan  
**Figaro** and a combi oven **Invoq**  
to get **great advantages:**

- > **Fewer units,**
- > **Less space used,**
- > **Fewer connections,**
- > **Fewer hoods,**
- > **Less floor grating.**

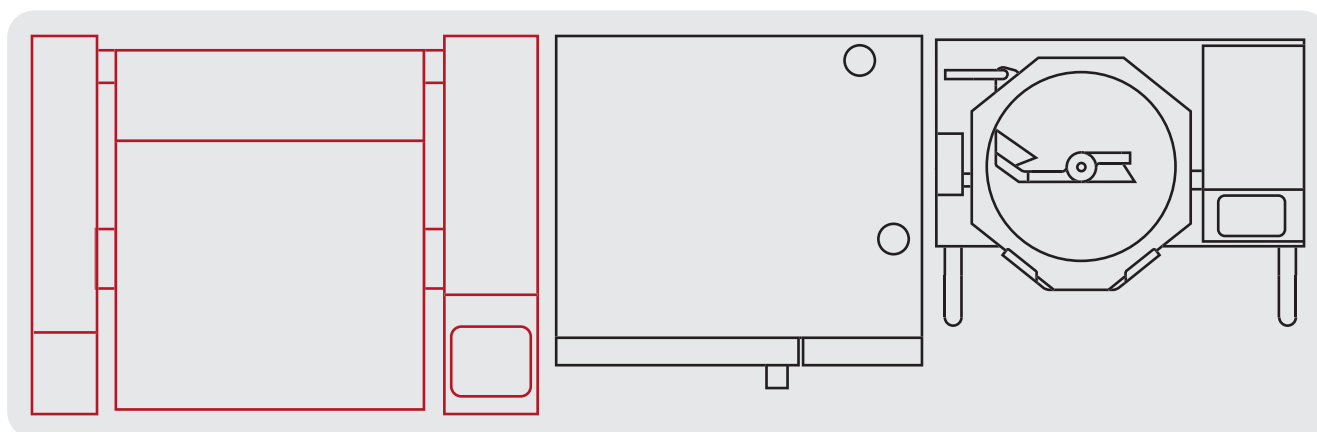
**Figaro DFIE100A****Invoq Combi 10-1****Cucimix 30**

**Firex solution: space used → 2,87 m<sup>2</sup>**



Figaro DFIE100A



Invoq Combi 10-1

# Programmability and consistent results.





With the FTC  
**(Firex Touch Control)**  
electronic control board,  
you can set any type of  
cooking and programme  
the preparation of the  
dishes in just a few seconds.

**Save your recipe  
on the electronic  
board and let Cucimix  
take care of the cooking.**

**Firex Touch Control** is our **next-generation**  
and extremely user-friendly electronic board,  
which is suitable to any operator.

**It features an intuitive interface** to create  
and store customised cooking programs.

**It manages the energy consumption in  
autonomy** be able to quickly reach precise  
and even temperature inside the tank.

This technology provides step-by-step  
guidance during the cooking process  
and notifies the operator only when  
intervention is required.



## Pressure cooking: one solution, multiple advantages.



Reduction of cooking times up to

# 70%

Cooking under pressure with Cucimix will lead to significant reduction of the cooking times up to 70% compared with traditional cooking methods.



Yield increase

# 30%

Up to 30% more yield compared to traditional cooking methods, almost no loss of water by evaporation in the Cucimix pressure cooking.



Annual costs saving

# 62%

-62% annual costs (energy, maintenance) compared with traditional pans to achieve the same production.



Energy saving up to

# 70%

Up to 70% energy saving compared with an array of traditional cookers to obtain the same quantity.

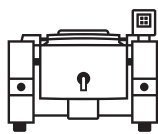
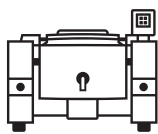
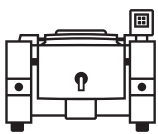

Reduction of installation costs up to

# 27%

These advantages allow you to upgrade from a set of 5 traditional cookers to one of 3 pressure cookers, while maintaining the same level of productivity.

Case study **McColgan's**

**Save up to 70% of time  
and energy costs:  
let Cucimix work in  
complete autonomy.**

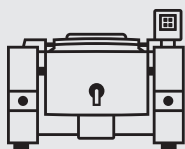

**VS**

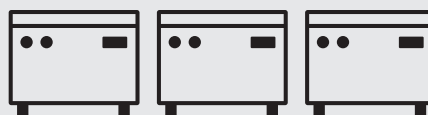

### **1 Cucimix**

310 litres

### **3 Traditional bratt pans**

3 × 100 litres = 300 litres

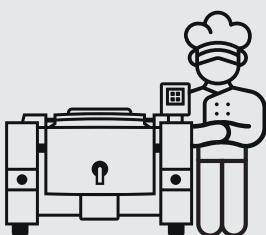

**VS**

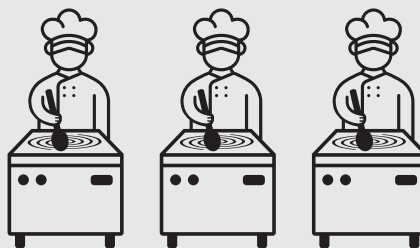

### **1 Person**

Programming + finishing

### **3 People**

Mixing + monitoring



**VS**



### **Supervision time:**

#### **1 person**

For 1/4 of their  
working hours

### **Supervision time:**

#### **3 people**

Full time

## Cooking professionally and saving.

Working with a professional steam, gas or electric bratt pan **Cucimix** guarantees considerable reduction in terms of **cooking times, labour and energy consumption and opens up new culinary possibilities.**



# Countless cooking modes for each recipe.

## Pressure cooking

With **Cucimix** you can cook under pressure at max **0,45 bar**, which allows you to **be 4 times faster** while maintaining a higher level of nutrients in the finished product.

Compared to traditional cooking methods, using pressure allows you to: **increase the yield, reduce the annual costs and improve the safety level of the working environment.**



## Braising and browning

With **Cucimix** you can cook **braised meat, stews and meat-based sauces like Bolognese sauce** enhancing the flavours and preserving all the organoleptic qualities of the ingredients. Thanks to the **FTC** electronic board you can **set, save and control each step of the cooking process** to achieve perfect browning at all times.





### Caramelising

**Cucimix** manages each step of the caramelising process thanks to the temperature control probes and the FTC electronic board, which controls all variables of the process that can be saved in multi-step recipes.

With **Cucimix** you can make even **dry caramel** and **you can prepare any kind of caramel-based filling**, caramelised dried fruit and fudge.



### Boiling

In the 30 litres version, **Cucimix** can be equipped with a **boiling kit** that makes it the perfect unit to **cook pasta and rice**. In fact, you can use up to four baskets and have **constant control of the temperatures**.



### Sous-vide, pasteurising and jar cooking

The **multifunctional basket** is perfect for steam cooking, boiling, pasteurising jars and sous-vide cooking.

# **Cucimix: versatile and compact.** **Food service, pastry** **and food industry.**



**Your best recipe:**  
**consistent results**  
**every time.**

## **Cucimix** your ally in the kitchen.



**Cucimix** is the perfect **professional cooker** to suit the needs of the food service, food industry and pastry sectors.

**It is extremely user-friendly, compact in size and designed with high-end technology to be able to support the operator in each step of the cooking process.** Through the integrated electronic board Firex Touch Control – FTC you can save and programme any recipe, guaranteeing flexibility and precision in the execution.

**The entirely programmable mixer**, with adjustable speed rotation in both directions, releases the

operator from the struggles of supervising the cooking process and guarantees **standardised processes.**

**An integrated probe system ensures precise control of the temperatures.**

With **Cucimix**, you have complete control over the entire cooking process, in full compliance with the safety standards. This is why you can **recreate the same quality of small productions even in larger batches and achieve consistent results.**

## Food service

# Chef Alessio Bottin



I have successfully been using **Cucimix 30 litres** for **over 10 years**. I first discovered it out of the pure necessity of producing fruit purees for kids that were suitable also for jar cooking and distribution in pharmacies. **Since then, this versatile and product-friendly machine has become a must in my lab.** Besides being able to work overnight and mastering the preparation of creams, it's the perfect machine for me to make pasta desserts and typical Italian dishes. I can set multi-step functions, **save recipes right from the touchscreen panel and control the temperatures** in a very precise way: this is why **Cucimix** makes my job easier and gives me flexibility to take on other tasks in the kitchen. I highly recommend **Cucimix** to anyone as its automated processes allow me to have the time to unleash my creativity in the kitchen.

The perfect mix for your kitchen



**“ Cucimix makes my job easier and offers flexibility in the kitchen ”**



## Pastry

# MOF Pastry Chef Angelo Musa

Best Craftsman of France  
World Pastry Champion



I successfully launched my “Papilio” jams line two years ago and that is when I discovered the **Cucimix cooker by Firex**. Since then, it has **completely changed the way I make jams, allowing me to manage large quantities extremely easily**. I strongly recommend **Cucimix** to all pastry chefs because its precision and versatility will save precious time in the kitchen. This machine has become my best ally when making pralines, compotes and fruit-based preparations. Personally, I have already purchased one **Cucimix** unit for a pastry shop I will open in Dubai and I invite everyone to buy theirs: you will see it's a game changer **to improve the level of your creations**.



**“ Cucimix is a must to increase the level of your creations. ”**

## Heating system: your choice. 3 options available: gas, electric, steam.

### Cucimix CBT 90 . 130 . 180 . 310 litres

Model	Dimensions (mm)	Mixer speed (rpm)	Mixer torque (Nm)	Pressure cooking (bar)	Total volume (it)	Pan dim. (mm)	Cooking vessel		modd. CBTE..C (kW)	Steam capacity (kg/h)
							Gas Version	Electric Version		
							220-240V 1N 50 Hz	380-415V 3N 50/60 Hz		220-240V 1N 50 Hz
<b>CBT 090 V1</b>	1455×1285 h. 1335	6÷21	160	-	90/115	700 Ø h. 300	22	13.5	17.1	70
<b>CBT 130 V1</b>	1455×1285 h. 1335	6÷18	191	-	130/154	700 Ø h. 400	28	13.5	18.2	70
<b>CBT 180 V1</b>	1655×1505 h. 1335	6÷14	236	-	180/223	900 Ø h. 350	33	21.0	26.4	100
<b>CBT 310 V1</b>	1655×1555 h. 1335	4÷10	353	-	310/353	1000 Ø h. 450	49	29.0	36.8	120
<b>CBT 130A V1</b>	1455×1270 h. 1335	6÷18	191	0.45	135/162	700 Ø h. 420	28	13.5	18.2	70
<b>CBT 180A V1</b>	1655×1500 h. 1335	6÷14	236	0.30	190/235	900 Ø h. 370	33	21.0	26.4	100
<b>CBT 310A V1</b>	1755×1550 h. 1335	4÷10	353	0.30	320/369	1000 Ø h. 470	49	29.0	36.8	120

#### Gas versions 70 . 90 . 130 . 180 . 310

Heating occurs by means of **high-efficiency burners**. The ignition and surveillance systems are managed **electronically** through the FTC panel, which allows you to reach the set-point very precisely avoiding energy waste.

#### Electric versions 30 . 70 . 90 . 130 . 180 . 310

Heating occurs by means of **heating elements**, that **fully cover the bottom of the pan**, thus ensuring even temperature over the entire surface.

**.C version** includes **heating of the walls on three levels, that are independent from one another** and can be activated separately depending on the quantity of the product in the pan. This feature increases the heating power and guarantees faster processes. Wall scraper included.

#### Steam versions 90 . 130 . 180 . 310

Thanks to the special **micro-cell technology on the bottom of the pan** and the use of 8 bar steam pressure, you can instantly reach the set temperature.



**CBT A  
Pressure**

**Cucimix CBT**  
**30 . 70 litres**
**Cooking vessel**
**Cooking vessel**

Model	Dimensions (mm)	Mixer speed (rpm)	Mixer torque (Nm)	Total volume (it)	Pan dim. (mm)	Gas power (kW)	Electric power (kW)	Electric connection (V/Hz)
<b>CBTE 030 V1</b>	880×766 h. 970	6÷20	48	30/37	450 Ø h. 235	-	6.2	380-415V 3N 50/60 Hz
<b>CBTE 030C V1</b>	880×766 h. 970	6÷20	48	30/37	450 Ø h. 235	-	8.0	380-415V 3N 50/60 Hz
<b>CBTG 070 V1</b>	1080×830 h. 1060	7÷22	96	70/82	600 Ø h. 290	16	0.6	220-240V 1N 50 Hz
<b>CBTE 70 V1</b>	1080×715 h. 1060	7÷22	96	70/82	600 Ø h. 290	-	9.6	380-415V 3N 50/60 Hz
<b>CBTE 070C V1</b>	1080×715 h. 1060	7÷22	96	70/82	600 Ø h. 290	-	12.6	380-415V 3N 50/60 Hz

**CBT**

**CBTG070 V1**  
**CBTE070 V1**  
**CBTE070C V1**

**CBTE030 V1**  
**CBTE030C V1**

# Your Cucimix

Customise **Cucimix** to your needs, **choose the accessories of your cooker now.**

## Accessories

For Cucimix:  
**30 . 70 litres**

### Multi-purpose basket

Ideal for steam cooking, boiling, pasteurisation of jars and sous-vide cooking. Its rotation guarantees even temperature in each area of the tank, which is essential when cooking in bags.



For Cucimix:  
**30 . 70 litres**

### Boiling kit

Transforms the bratt pan into a practical 4-basket (30 lt version) or 6-basket (70 lt version) kettle.



For Cucimix:  
**30 . 70 litres**

### Mixer grid

To achieve better distribution of the powders of the product, increasing the stirring capacity of the mixer.



For Cucimix:  
**90 . 130 . 180 . 310 litres**

### Mixer grid

Can be attached to the mixer: it increases the performance of the mixer, especially in case of particularly thick products, guaranteeing creaminess.

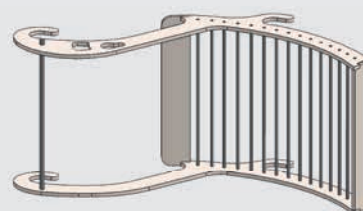

For Cucimix:  
**30 . 70. 90 . 130 . 180 . 310 litres**

#### Wall scraper

Additional scraper made of steel and food-grade teflon, perfect for scraping the food off from the walls.

Scrapers available also in PEEK material, recommended for caramel production.



For Cucimix:  
**30 . 70 litres**

#### Cleaning mixer

Mixer with brushes for the automatic cleaning of the walls and bottom of the tank.



For Cucimix:  
**30 . 70. 90 . 130 . 180 . 310 litres**

#### Strainer

Practical help to separate the product from the cooking liquids. It fits easily on the upper part of the pan and remains firmly attached to the machine for the complete drainage of liquids.



# Your Cucimix

Customise **Cucimix** to your needs.

## Optional

For Cucimix:  
**90 . 130 . 180 . 310 litres**

**Plexiglass cover for the FTC**



For Cucimix:  
**90 . 130 . 180 . 310 litres**  
(no pressure)

**Single lid with hopper (Ø 400 mm) / steam exhaust**

Wide opening for easy addition of ingredients during the cooking process with the lid closed.



For Cucimix:  
**90 . 130 . 180 . 310 litres**

**Power socket**  
230V 2P+T 16A to be able to have electrical connection at any time.



For Cucimix:  
**30 . 70 . 90 . 130 . 180 . 310 litres**

**Hand shower**  
for machine cleaning



For Cucimix:  
**30 . 70 litres**

**Mixer tap**  
To load water into the pan.  
Cannot be installed together with the shower head.



For Cucimix:  
**30 . 70 litres**

**Core probe**  
Ideal for detecting the temperature at the core of the product.  
Used for pasteurising jars and sous-vide cooking with the rotating basket.



For Cucimix:  
**70 . 90 . 130 . 180 . 310 litres**

#### Butterfly or ball discharge valve

Butterfly or ball valve, useful for the drainage of liquid or semi-liquid products, or for connection to automatic dosaging systems.



For Cucimix:  
**90 . 130 . 180 . 310 litres**

#### Flush valve

Allows to discharge product in big chunks and avoids that they remain stuck in blind spots, guaranteeing homogeneity.



For Cucimix:  
**130 . 180 . 310 litres** (with pressure)

#### Pneumatic valve

Managed by the FTC board can be opened only under conditions of absolute safety.



For Cucimix:  
**30 litres**

#### Pull-out container



For Cucimix:  
**30 . 70 . 90 . 130 . 180 . 310 litres**

#### Wheels

(standard on 30 litres version)

The wheels offer the possibility to move around the machine and to be able to redesign the kitchen space according to your needs.



For Cucimix:  
**90 . 130 . 180 . 310 litres**

#### Flanged feet

The flanged feet ensure maximum stability to the machine. They can be fixed to the floor thanks to the flanges.



For Cucimix:  
**70 . 90 . 130 . 180 . 310 litres**  
(no pressure)

#### Wash-out hole stopper

The cap guarantees hermetic closure of the pan and avoids that some product remains stuck in blind spots when the valve is not necessary.



# Discover **Firex** services.



**Start-up  
supervision**



**On-site or online  
commissioning**



**Food  
technologist  
consulting**



**Pre-delivery  
on-site or online  
technical training**



**Customised on-site  
or online demos**



**FirexLab,  
video recipes**

 [Firex \(@Firexsrl\)](#)

 [@firex\\_srl](#)

 [Firex | Attrezzature per la ristorazione professionale](#)

 [Firex \(@Firex-foodequipment\)](#)



**firex**  
Share the taste



**Firex s.r.l.**  
Zona Industriale Gresal, 28  
32036 - Sedico (Belluno) Italy  
tel. +39 0437 852700  
firex@firex.com